

# How to Order and Specify

MODEL	SERIES	FINISH	FUNCTION DESCRIPTION	FUNCTION CODE	BACKSET	DOOR HANDING (if required)	DOOR THICKNESS (if required)
MR660	RRW	US3	PASSAGE	50	2 3/4"	LH	1 3/8"

Examples: **LONG NARROW PLATES SERIES**

MR660	CNP	US15	PRIVACY	15	2 3/4"	LH	1 3/8"
-------	-----	------	---------	----	--------	----	--------

## SERIES

CODE	DESCRIPTION	HEIGHT		WIDTH		THICKNESS	
		mm	inches	mm	inches	mm	inches
<b>LONG NARROW PLATES</b>							
ENP	CAMEO NARROW PLATE	255	9.8	44	1.7	13.5	0.5
MNP	MIAMI NARROW PLATE	250	9.8	44	1.7	13.5	0.5
LNP	LADY NARROW PLATE	245	9.6	45	1.8	9.6	0.4
VNP	VANCOUVER NARROW PLATE	240	9.4	42	1.7	10	0.4
QNP	QUEEN NARROW PLATE	270	10.6	48	1.9	10	0.4
CNP	CHEDDINGTON NARROW PLATE	250	9.8	45	1.8	9.6	0.4
<b>LONG WIDE PLATES - CONCEALS 2 1/8" STD. HOLE</b>							
EWP	CAMEO WIDE PLATE	255	9.8	62	2.4	13.5	0.5
MWP	MIAMI WIDE PLATE	250	9.8	60	2.4	13.5	0.5
CWP	CLASSIC WIDE PLATE	245	9.6	58	2.3	10	0.4
BWP	BEADED WIDE PLATE	245	9.6	60	2.4	10	0.4
RWP	RIBBON WIDE PLATE	280	11.0	58	2.3	10	0.4
HWP	CHATEAU WIDE PLATE	286	11.3	60	2.4	10	0.4
NWP	COUNTRY WIDE PLATE	260	10.2	75	3.0	13.5	0.5
SWP	STONESHORE WIDE PLATE	235	9.3	60	2.4	13.5	0.5
STS	SMALL STONESHORE WIDE PLATE	180	7.1	60	2.4	13.5	0.5
VWP	VANCOUVER WIDE PLATE	245	9.6	58	2.3	10	0.4
LWP	LEGACY WIDE PLATE	330	13.0	61	2.4	10	0.4
GWP	BARRINGTON WIDE PLATE	275	10.8	70	2.8	10	0.4
DWP	CHEDDINGTON WIDE PLATE	250	9.8	60	2.4	9	0.4
<b>SHORT PLATES - CONCEALS 2 1/8" STD. HOLE</b>							
ESP	CAMEO SHORT PLATE	127	5.0	63	2.5	10	0.4
FAP	FIFTH AVE. SHORT PLATE	127	5.0	63	2.5	10	0.4
MSP	MIAMI SHORT PLATE	127	5.0	63	2.5	13.5	0.5
MAP	MANHATTEN AVE. SHORT PLATE	127	5.0	63	2.5	10	0.4
<b>LARGE ROSETTE - CONCEALS 2 1/8" STD. HOLE</b>							
ERR	CAMEO LARGE ROSETTE	68	2.4	68	2.4	10	0.4
RR-W	WAVE LARGE ROSETTE	62	2.4	62	2.4	10	0.4
RR-B	BEADED LARGE ROSETTE	62	2.4	62	2.4	10	0.4
RR-P	PLAIN LARGE ROSETTE	62	2.4	62	2.4	10	0.4
RR-S	SQUARE LARGE ROSETTE	62	2.4	62	2.4	10	0.4
RR-C	COUNTRY LARGE ROSETTE	93	3.7	73	2.9	10	0.4
RR-M	MIAMI LARGE ROSETTE	66	2.6	66	2.6	13.5	0.5
<b>SMALL EURO ROSETTE</b>							
R8	SMALL ROSETTE ROUND	55	2.2	55	2.2	10	0.4
R8S	SMALL ROSETTE SQUARE	55	2.2	55	2.2	10	0.4
R8SD	SMALL ROSETTE SQUARE DIAMOND (Mounted Diamond 45 Degree)	55	2.2	55	2.2	10	0.4

## CREATE YOUR OWN PERSONALIZED STYLE

Example: **LONG NARROW PLATES SERIES**

MODEL	SERIES	FINISH	FUNCTION DESCRIPTION	FUNCTION CODE	BACKSET	DOOR HANDING (if required)	DOOR THICKNESS (if required)
AUR595	<b>PLATE X STEM X LEVER</b>		PRIVACY	15	2 3/4"	LH	1 3/8"
	ENP (Cameo Plate)	X US19					
	RD (Round Stem)	X US15					
	AUR59 (Linea Bliss)	X US19					

LINEA BLISS  
AUR595

LINEA ONDA  
AUR590

LINEA OCTAVO  
AUR585

LINEA FILA  
AUR605

LINEA MIAMI  
AUR580

### Step 1

#### Pick a Back Plate & Finish

*Narrow Plate, Wide Plate, Short Plate, Large Rosette or Small Rosette*

### Step 2

#### Pick a Stem & Finish

ROUND (RD)



SQUARE (SQ)



### Step 3

#### Pick a Lever & Finish

LINEA BLISS  
AUR595



LINEA ONDA  
AUR590



LINEA OCTAVO  
AUR585



LINEA FILA  
AUR605



LINEA MIAMI  
AUR580



<b>SERIES</b>		
<b>CODE</b>	<b>DESCRIPTION</b>	
05	<b>PASSAGE</b>	Standard Tubular Latch (specify 2 3/8" or 2 3/4")
10	<b>PASSAGE</b>	Standard Euro-Mortise Box 2" Backset
15	<b>PRIVACY</b>	Combination Latch & Bolt (specify 2 3/8" or 2 3/4")
20	<b>PRIVACY</b>	Standard Euro-Mortise & Turnbolt 2" Backset
30	<b>SINGLE DUMMY</b>	Surface Mounted Spindle
32	<b>DOUBLE DUMMY</b>	Two Surface Mounted Spindles
40	<b>KEYED</b>	Euro-Mortise & Single Profile Cylinder 2" Backset
47	<b>KEYED</b>	Latch and Bolt 3 1/2" Centers Cylinder below lever 2 3/8" or 2 3/4" Backset
50	<b>PASSAGE</b>	Round Rosette Series Passage with Tubular Latch (Conceals 2 1/8" cutout)
55	<b>PRIVACY</b>	Round Rosette Series Privacy with Tubular Latch (Conceals 2 1/8" cutout)
60	<b>SINGLE DUMMY</b>	Round Rosette Series Surface Mounted one-sided
62	<b>DOUBLE DUMMY</b>	Round Rosette Series with Blocker for Pre-Drilled Hole
80	<b>ENTRANCE TUBULAR</b>	Tubular Entrance Set Round Cylinder 5 1/2" Hole Centers
85	<b>ENTRANCE MORTISE</b>	Heavy Duty AM500 Mortise 2 1/2" or 2 3/4" Backset
87	<b>ENTRANCE TUBULAR</b>	Tubular Entrance Set Narrow Cylinder 5 1/2" Hole Centers
82	<b>ENTRANCE FULL DUMMY</b>	Full Dummy Set for Entrance Sets
90	<b>MULTI-LOCK TRIMS</b>	Trim sets for existing Multi-lock Mechanisms Available for A-B-C Specifications (Includes Plates, Levers, and Cylinders)

**Polished Brass - US3**



**Satin Brass - US4**



**Satin Nickel - US15**



**Oil Rubbed Bronze - US10B**



**Polished Nickel - US14**



**Pewter - US15A**



**Flat Black - US19**



**Polished Chrome - US26**



**Antique Brass - US5**



# H E L P

## EXISTING DOOR CONDITIONS

### 1 Confirm existing door conditions.

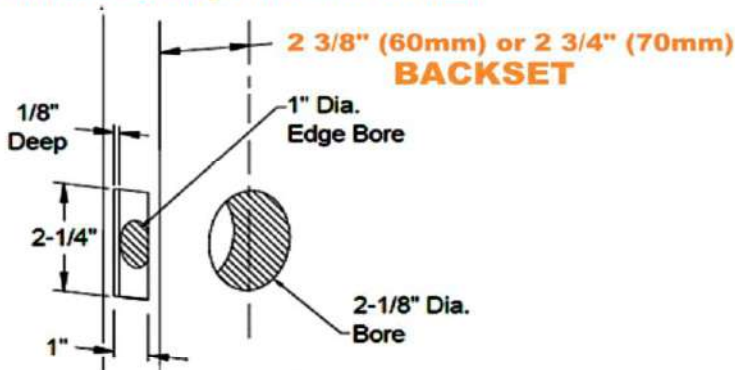

### T I P S

- Door Handing May Be Required
- Take Notes for Future Reference

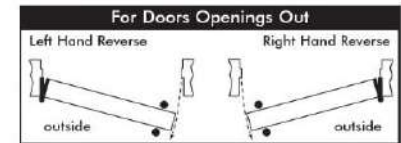
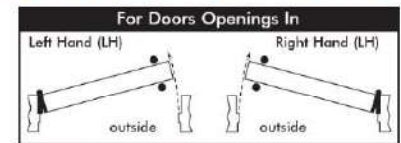

### 2 There are only 2 backsets available. Please measure closest to below. Either 2 3/8" (60mm) or 2 3/4" (70mm)

#### MEASURING THE BACKSET

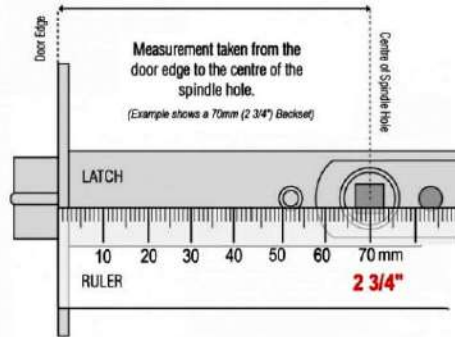
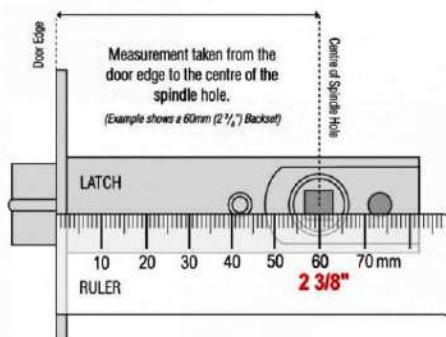

### 3 Count doors has required

#### PASSAGE SET

- Active latch with no locking mechanism.
- The knob is always unlocked.
- Standard door range: 1-3/8" to 1-3/4" thick.

Qty: \_\_\_\_\_

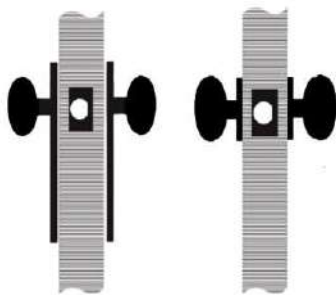

#### SINGLE DUMMY

- A non-functioning door set without a passage/privacy latch, and no locking mechanism, used on one side of the door (typically used with roller catch, flush bolts or surface bolts).
- Surface mounted.

Qty: \_\_\_\_\_

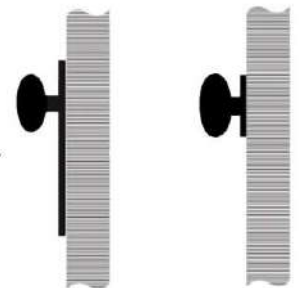

#### PRIVACY LOCK

- Active latch with a locking mechanism.
- Privacy pin or bolt provides locking through rose or long plate.
- Can be opened from outside with a release key.

Qty: \_\_\_\_\_

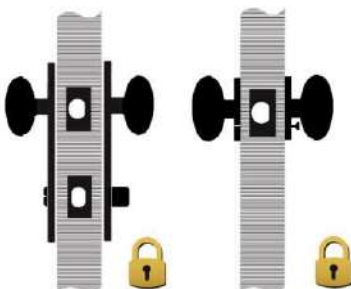

#### DOUBLE DUMMY

- Two non-functioning door sets (without a passage/privacy latch) are used on both sides of a door, or on side-by-side or French doors (typically used with roller catch, flush bolts or surface bolts).
- Surface mounted or thru-bolting.

Qty: \_\_\_\_\_

